

This document describes the various options for connecting your PC to your Renewable Energy (RE) equipment via the RE equipment manufacturer's PC interface. In all of the diagrams in this document, the "Host PC" is the PC on which the *WinVerter* software is running. The following table shows the RE equipment that is compatible with *WinVerter*, along with the required PC interface.

RE Equipment	PC Interface	WinVerter Product
Xantrex SW or PS series inverters	SWCA (one per inverter)	<i>WinVerter-Monitor SW</i> <i>WinVerter-Setup SW</i> <i>WinVerter-Control SW</i>
Xantrex SW Plus series inverters	ICA (one per inverter)	Available 2005
OutBack FX series inverters	Mate (one per system, Hub required for multiple devices)	<i>WinVerter-Monitor FX-MX</i>
OutBack MX series charge controllers	Mate (one per system, Hub required for multiple devices)	<i>WinVerter-Monitor FX-MX</i>

NOTE

When monitoring a stacked pair of Xantrex SW inverters, *WinVerter-Monitor SW* requires two Com Port connections between the RE equipment and the Host PC; one to each of the inverters, both equipped with the SWCA. The OutBack Mate and the Xantrex ICA only require a single Com Port connection to the Host PC regardless of how many devices are being monitored.

The following are some of the methods used to connect a Host PC to the RE equipment PC interface.

1. HOST PC IS ON-SITE, AND NEAR TO THE RE EQUIPMENT.

This configuration is the most simple because it uses factory supplied, or readily available cables.

In the case of Xantrex, the SWCA or ICA (PC interfaces) comes with everything you need to connect your PC up to 25 feet from the RE equipment.

In the case of OutBack, the Mate (PC interface) can use a readily available, standard male-to-female 9-pin D-sub cable up to 25 feet long to connect to your PC. This cable is not supplied by OutBack. Refer to the end of this document for a list of cable sources.

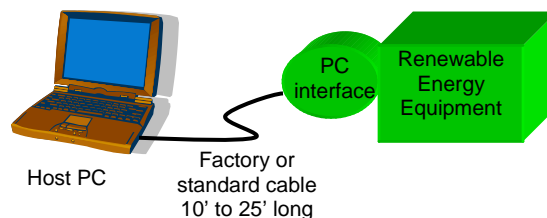

2. HOST PC IS ON-SITE, BUT FAR FROM THE RE EQUIPMENT

2.1. Connect via Extension Cables

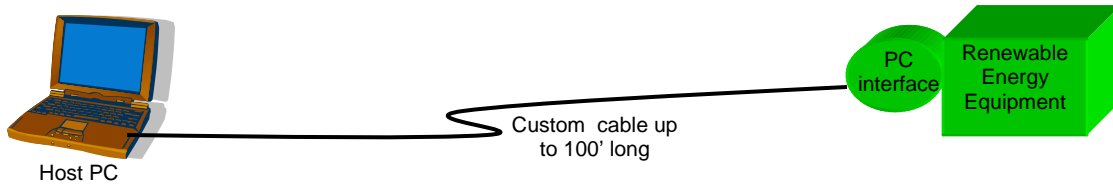

This option extends the connection via hard-wire with no additional electronics.

In the case of the Xantrex equipment, the SWCA/ICA cable is 4-conductor telephone wire. This can be extended using readily available, pre-made telephone line extensions (such as Radio Shack 279-441 25' Phone Extension Cord, \$10 US). Several of these extension cables can be daisy chained for a total of up to 100 feet of cable distance.

In the case of OutBack equipment the Mate can be remoted from the rest of the OutBack RE equipment by up to 1000 feet using standard Cat-5e cable (NOT cross-over cable). This allows the Mate to be in the same room as the PC where it is convenient to access.

In either case if you are running the cable through conduit, the cable typically can't be terminated until after it is run through the conduit. In this case refer to the appendix on how to make your own cable terminations.

2.2. Connect via RS-422

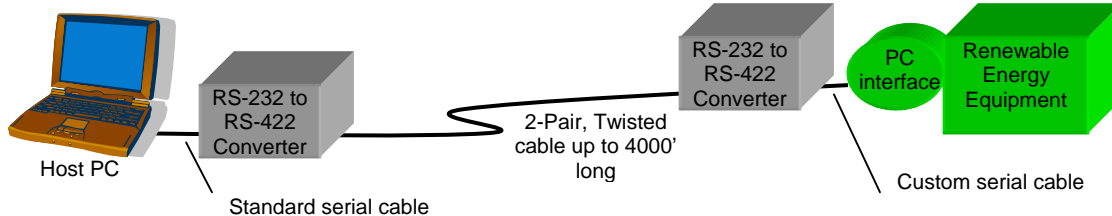

This option extends the connection up to 4000 feet using relatively inexpensive converter electronics. The electronics converts the serial RS-232 data used by the PC and the RE equipment PC interface, to RS-422 data, which can be transported up to 4000 feet over standard 2-twisted pair, 24 gauge telephone cable (such as Radio Shack 278-385 100' outdoor 4-conductor phone cable). The recommended converters are the B & B Electronics 485OI9TB Optically Isolated RS-232 to RS-422 Converters. The price for a pair of converters along with the needed 120 Vac-to-12 Vdc wall transformers is \$190 US.

This option works equally well for Xantrex or OutBack equipment. The connection from the Host PC to the associated RS-422 converter is accomplished using a standard male-to-female 9-pin D-sub cable. The connection from the RE equipment's RE interface to the associated RS-422 converter requires a custom made cable.

2.3. Connect via Ethernet

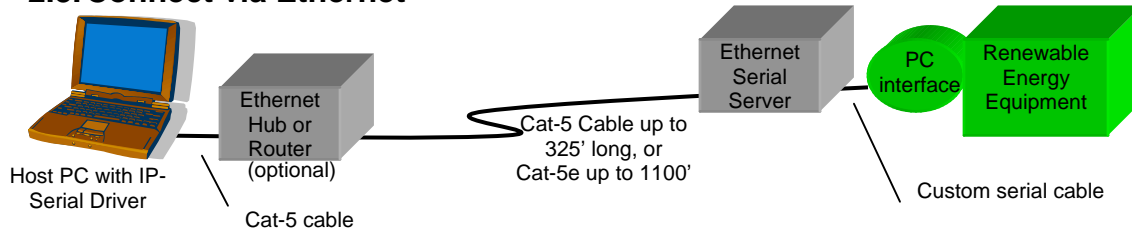

This option extends the connection to over 1000 feet by converting the serial RS-232 signals to Ethernet. The cable used to transport the Ethernet is either Cat-5 (good for up to 325 feet), or Cat-5e (good for up to 1100 feet). Be sure to avoid cross-over cable. The recommended converter is the B & B Electronics ESP901 RS-232 Ethernet Serial Server priced at \$150 (including the 120 Vac wall transformer). An Ethernet hub or router may be used in the system, but is not necessary. The Host PC must be equipped with an Ethernet port (NIC) and must have serial driver software installed. The driver software comes with the ESP901.

If the RE equipment comprises a stacked pair of Xantrex SW inverters, the ESP902 Dual Port Serial Server may be used to communicate with the SWCA's of both inverters. In the case of Xantrex equipment, the connection from the RE equipment's PC interface to the Ethernet Serial Server is made using standard male-to-female 9-pin D-sub cables. In the case of OutBack equipment, the connection requires a custom cable due to the Mate's optically isolated Com Port.

2.4. Connection via 802.11 (wireless Ethernet)

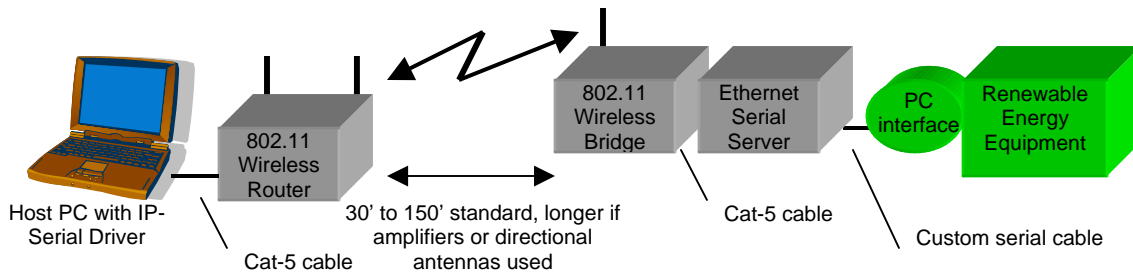

This option is an addition to the previous Ethernet-based connection option, adding 802.11 wireless connectivity. The wireless distance can vary from 30 to 150 feet using standard equipment. The distance can vary due to interference or obstructions to the line-of-sight between the two ends. The distance can be increased by using external directional antennas or 802.11 amplifiers. The recommended 802.11 equipment are the Linksys WET11 Wireless-B Ethernet Bridge at the RE equipment end and either another WET11 or a WAP11 Wireless-B Access Point at the Host PC end. Both devices operate from 120 Vac via a wall transformer (included). The cost of adding 802.11 (excluding external antennas or amplifiers) to an Ethernet-based connection is about \$160 US.

3. REMOTE, OFF-SITE MONITORING

The nature of the RE equipment PC interfaces makes it difficult to allow remote monitoring without some sort of intelligence to act as a “gateway” to the outside world. For that reason, RightHand Engineering’s recommends that a Host PC be located on site to act as the gateway.

For any of the remote monitoring options shown here, the on-site connection between the Host PC and the RE equipment should be one of those previously identified.

Often, remote monitoring is needed because the RE equipment site is unattended. For unattended sites, RightHand Engineering has the following recommendations for Host PCs in order to minimize the chance of PC failure or lockup.

- a. The Host PC should be running a professional grade operating system (OS), such as Microsoft Windows 2000 pro, or XP pro. Professional grade OS help protect one program from affecting another.
- b. The Host PC hardware should be compatible with the operating system that it hosts. Microsoft has a hardware compatibility list that can be used verify compatibility. Compatible PCs will generally also have a “Designed for..” Windows sticker applied to the PC case that shows which OSs it is compatible with.
- c. The Host PC should have the latest OS service packs and driver updates installed. Updates are generally issued to fix bugs which effect PC reliability.
- d. The Host PC should contain the recommended resources (RAM, processor, etc.) for the OS being used, as well as for all of the programs that it will run.
- e. The Host PC should be rated to operate over the temperature range expected to occur at the site. Generally if the PC contains a moving hard-drive and fan, it is not rated to operate below freezing. Specialty PCs are available that have no moving parts, are low power (sub 10 watt) and have an extended temperature range.
- f. The Host PC should have the minimum number of additional programs installed. Ideally, the Host PC would only contain the OS, *WinVerter*, and programs required for remote monitoring. Operating reliability decreases with each additional program this is run.
- g. *WinVerter* running on the unattended Host PC should be configured to automatically start-up with the PC start-up, and should be configured for unattended operation (see *WinVerter*’s manual regarding command line commands).
- h. If after implementing these suggestions the Host PC locks up periodically, you may want to consider adding software (such as UK Software’s *ShutUp*) or hardware that can automatically restart the PC every few days.

NOTE

Some remote monitoring options may involve interfacing with the internet. The installer will need to know the basics of PC networking and perhaps FTP in order to implement these options.

3.1. Remote Monitoring without Control

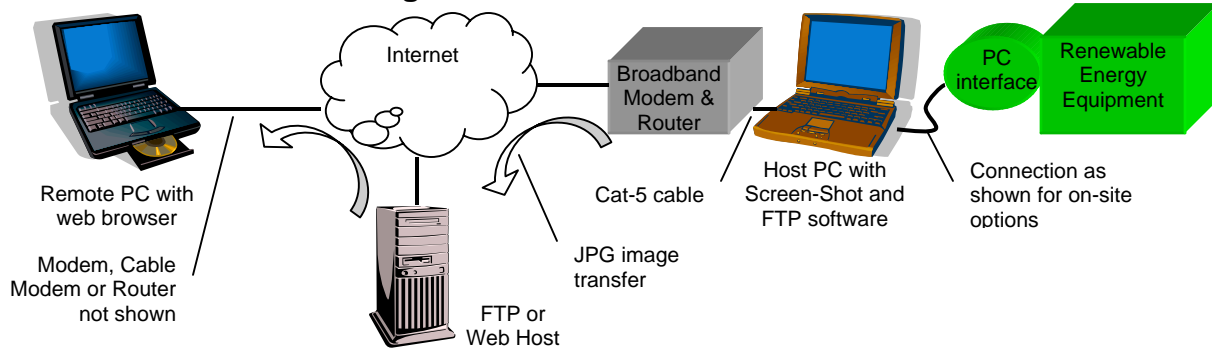

This option allows remote monitoring, but does not allow remote control. Remote monitoring is accomplished by using third-party software to create “screen shots” of *WinVrter* and FTP’ing (file transfer protocol) them to a web host or FTP host accessible on the internet. The recommended software is Moodysoft’s *SPX Instant Screen Capture* for creating screen shots in web-compatible JPG format, and for transferring the screen shot via FTP to a web or FTP host. *SPX Instant Screen Capture* can be scheduled to do its work on a periodic basis, for example every 30 minutes. The current price for *SPX Instant Screen Capture* is about \$25 US.

If you do not have a web or FTP host, you may want to consider using ZFTP.com, Plan A with a monthly cost of about \$6 US. The recommended method of connecting the Host PC to the internet is via broadband (DSL, cable modem or satellite) using a compatible modem/router. Dial-up may also work, but will be considerably slower and more prone to failure, especially if the dial-up line is not dedicated to the Host PC. If dial-up is used, the minimum recommended connection speed is 28.8 Kbps.

3.2. Remote Monitoring with Control

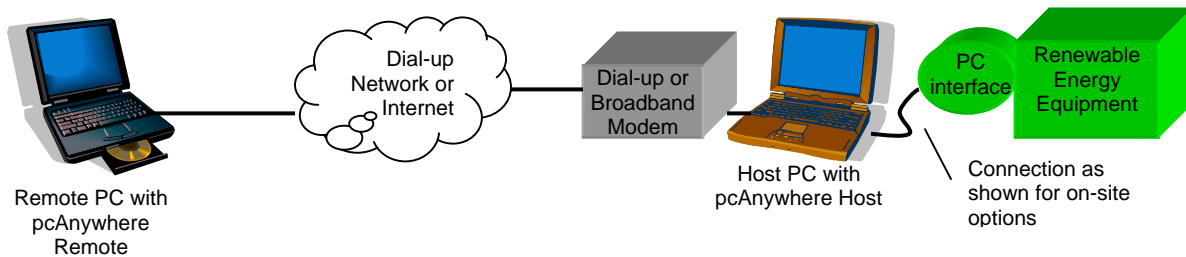

This option allows remote monitoring and remote control. This is accomplished using remote PC access software, such as Symantec's *pcAnywhere*, RealVNC's *VNC*, or *Remote Desktop* if using Microsoft Windows XP Pro. Such software allows a remote PC to fully emulate the Host PC at the RE equipment site, just as if the remote PC user were sitting in front of the Host PC. The remote user is able to view the *WinVerter* screen, bring up the control panel window to control the inverter, and transfer data log files from the Host PC to the remote PC. *pcAnywhere* has a retail price of \$200 US, but can be obtained on the web as low as \$40 US (without support). Be sure to obtain both the Host and Remote portions of *pcAnywhere* which are sometimes sold separately. *VNC* is freeware but may lack some of the security features of *pcAnywhere*. *Remote Desktop* is part of Windows XP Professional.

Most remote PC access software will allow access via either the internet or direct dial-up access. If internet is used, provisions will need to be made to any router or firewall in the system. If dial-up is used, the minimum recommended connection speed is 28.8 Kbps. It may also be possible to provide access via cellular modems.

4. TROUBLESHOOTING

For assistance in troubleshooting serial Com Port connections between the Host PC and the PC interface, refer to the document *RHE Com Port Troubleshooting*.

NOTE

Although RightHand Engineering has tried most of the connection options outlined in this document, we can not guarantee the applicability of these options to your particular environment. The skills required to implement these options vary considerably from basic electrical skills, to IT skills. Therefore, these options are implemented at your own risk.

RightHand Engineering is able to provide support for those products which we sell. Support for products sold by other companies, including those recommended for these connection options, must be obtained through those companies or the equipment manufacturer.

5. EQUIPMENT, SOFTWARE AND SERVICE SOURCES

- B & B Electronics. One source of RS-232 converter devices. www.bb-elec.com, phone (815) 433-5100.
- LinkSys (Cisco). One source of 802.11 Wireless Ethernet devices, available through computer and office supply stores. www.linksys.com
- Radio Shack. One source of cables, wire and connectors. Stores are located in most towns in North America. www.radioshack.com
- Belkin. One source of pre-made cables and USB converters, available through computer and office supply stores (the Belkin RS-232 cable is not recommended for use with the OutBack Mate because its retaining hardware interferes with the Mate's 9-pin connector). www.belkin.com
- Symantec. One source of remote PC access software (such as pcAnywhere), available directly, web-sales (such as www.pcanypwhere.com) or through computer stores. www.symantec.com
- RealVNC. Another source of remote PC access software (such as VNC). www.realvnc.com
- UK Software. One source of PC-reboot software. www.uk-software.com
- Moodysoft. One source of screen capture/FTP software (SPX Instant Screen Capture). www.moodysoft.com
- ZFTP.com. One source of inexpensive FTP web hosting. www.ZFTP.com

Male-to-Female, 9-pin, D-sub Cables

- Radio Shack 6-foot DB9 Extension Cable for Monitor or Mouse, 26-117, \$14 US.

6. APPENDIX

When placing cable in a conduit, it is best not to have terminations on the cable which can increase the difficulty in threading the cable through the conduit. This section shows you how to terminate phone or Cat-5 cable after it has been placed in conduit.

6.1. How to Terminate Phone Cable

When extending the PC cable of a Xantrex inverter through conduit, 4-wire telephone cable is used. It is recommended that out-door 24-gauge solid-wire (not stranded-wire) cable be used for this. To terminate solid wire you should use surface mount wall jacks (a.k.a. "biscuits") to connect the solid wire to a phone-type jack, then use standard phone cables to connect the jacks to the equipment at each end. Note that the wire colors are reversed from one end to the other. Refer to the diagrams below.

Surface Mount Phone Jack wire colors – PC end	Phone cable wire colors	Surface Mount Phone Jack wire colors – RE Equipment end
Yellow	Yellow or Orange w/ white stripe	Black
Green	Green or White w/ blue stripe	Red
Red	Red or Blue w/ white stripe	Green
Black	Black or White w/ orange stripe	Yellow

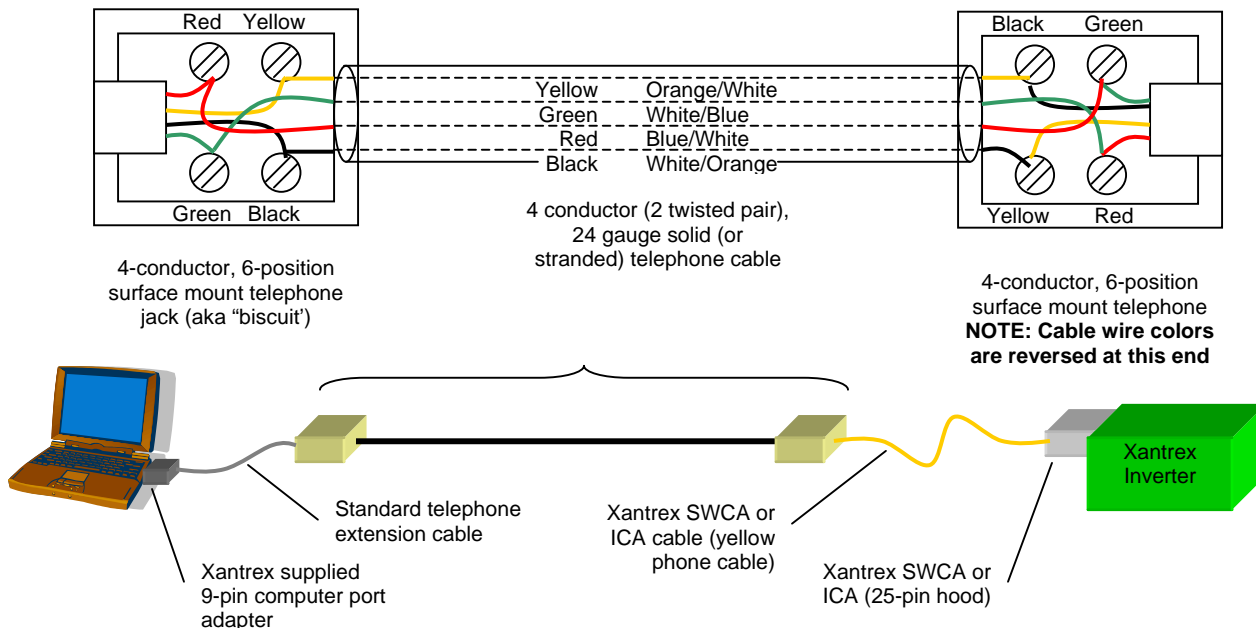

6.2. How to Terminate Cat-5 Cable

Pin	Signal	Cable wire color
1	Transmit +	White/Green
2	Transmit -	Green/White
3	Receive +	White/Orange
4	N/A	Blue/White
5	N/A	White/Blue
6	Receive -	Orange/White
7	N/A	White/Brown
8	N/A	Brown/White

